

3W, Mono, Fully Differential Audio Power Amplifier

General Description

The CP2293 is a fully differential audio power amplifier designed for demanding audio applications. It is capable of delivering 3 watt of continuous average power to a 3Ω BTL load with less than 10% distortion (THD+N) from a 5V battery voltage. It operates from 2.2V to 5.5V.

Features like -88dB PSRR at 217Hz, improved RF-rectification immunity, the space-saving CSP8, DFN8 and MSOP8 packages, the advanced pop & click circuitry, a minimal count of external components and low-power shutdown mode make the CP2293 ideal for wireless handsets.

The CP2293 is unity-gain stable, and the gain can be configured by external resistors.



CSP8 Package
1.5mm x 1.5mm
-40°C ~ 85°C



DFN8 Package
3mm x 3mm
-40°C ~ 85°C



MSOP8 Package
-40°C ~ 85°C

Features

- Fully differential amplifier
- Improved PSRR at 217Hz
- Power output at 5.0V, 10% THD, 3 Ω (DFN8 only)
- Power output at 5.0V, 1% THD, 8 Ω
- Ultra low shutdown current
- Improved pop & click circuitry eliminates noises during turn-on and turn-off transitions
- Thermal overload protection circuitry
- Unity-gain stable
- External gain configuration capability
- Available in space-saving packages: CSP8, DFN8 and MSOP8
- RoHS compliant and 100% lead(Pb)-free

-88dB (typ)
3W (typ)
1.3W (typ)
0.01μA (typ)

Applications

- Wireless handsets
- Portable audio devices
- PDAs
- Notebook computers

3W, Mono, Fully Differential Audio Power Amplifier

Pin Configurations

**CSP8 Package
(Top View)**

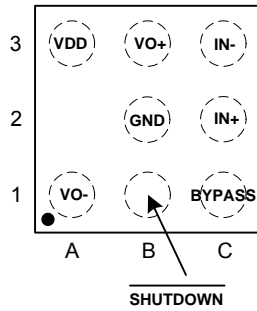

CSP8 Marking

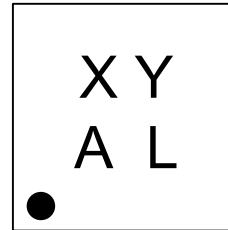

XY -Manufacture Date Code
AL - CP2293ITLX

**DFN8 Package
(Top View)**

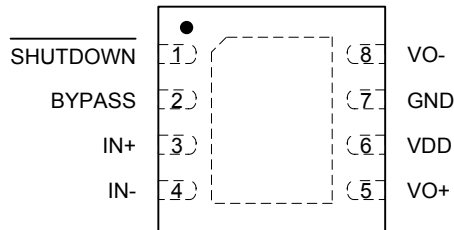

DFN8 Marking

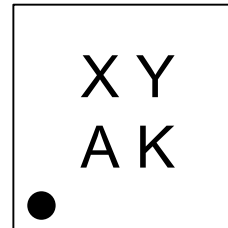

XY -Manufacture Date Code
AK - CP2293LD

**MSOP8 Package
(Top View)**

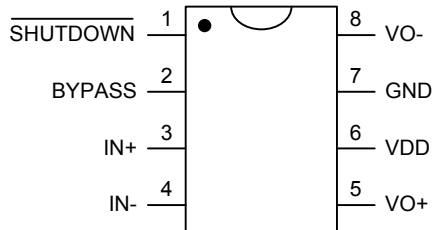

MSOP8 Marking

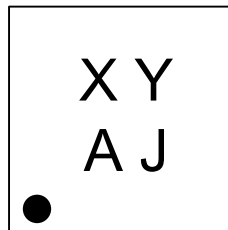

XY -Manufacture Date Code
AJ - CP2293MM

3W, Mono, Fully Differential Audio Power Amplifier

Typical Application Circuit

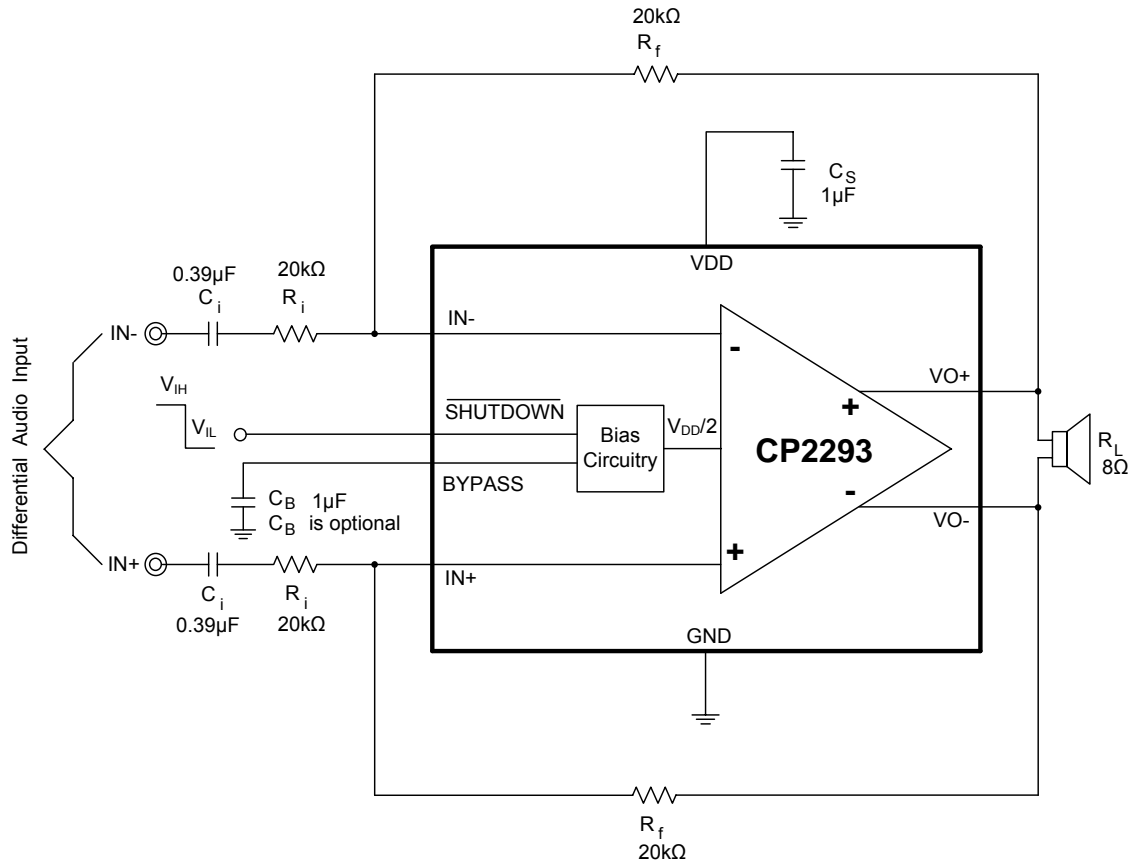

Contact with Chiphomer

4F, Building D, 1618 Yishan Road Shanghai, 201103, P.R.C.
 Tel: (86)21-64014543 64058488
 Fax: (86)21-64050030
 Sale: sales@chiphomer.com
 Technical support: support@chiphomer.com
 Web site: www.chiphomer.com

Shenzhen Office:
 10D, Building 2, Dushi Yangguang Garden CheGongMiao, Futian District, Shenzhen, 518048,
 P.R.C.
 Tel: (86)755-82046706 82047789
 Fax: (86)755-8204670